

WALL

# PRINTED PANELS

With diverse pattern options, Printed Panels are sure to suit any aesthetic and simultaneously offer acoustic refinement to create an alluring and cohesive environment.





# PATTERNS

Wall Panels are 9mm thick and available as 47.5" x 95" or 47.5" x 118.75". Printed Panels boast of vibrant graphic patterns that are sure to catch the eye of visitors to your space!

48" x 120" panels available in select colors.

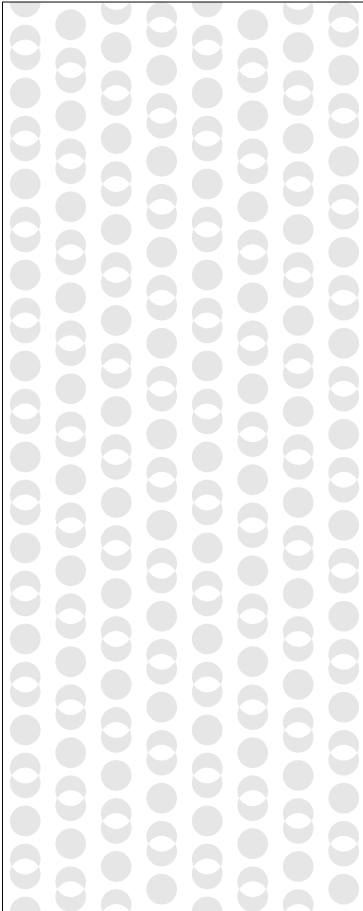

MOON

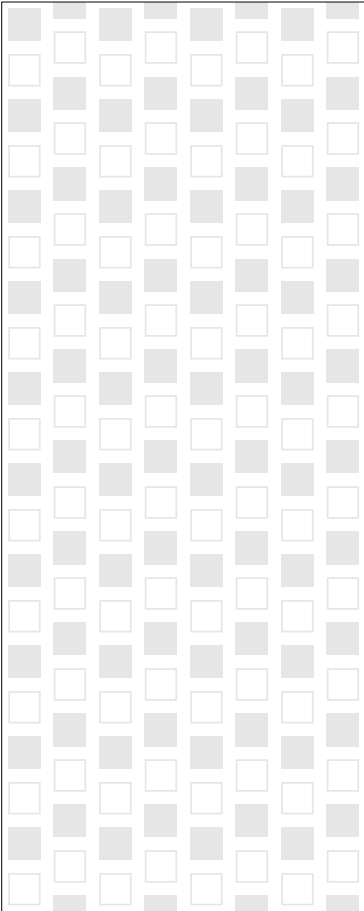

SQUARES 01

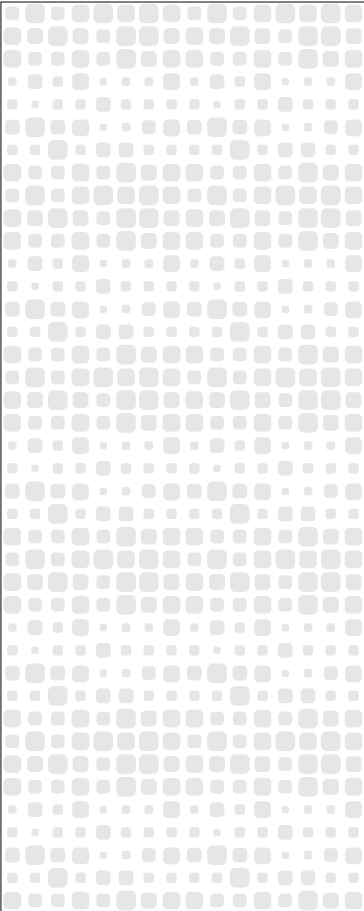

SQUARES 02



TRIANGLES

# COLOR GUIDE

9mm ArtFelt is the core material in our signature line of acoustic solutions.

Request samples to verify color as printers and monitors vary.



ECLIPSE

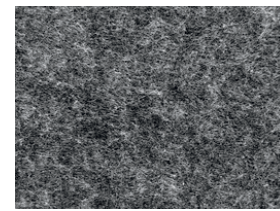

ASH

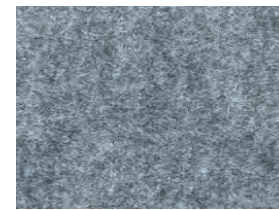

WEATHERED

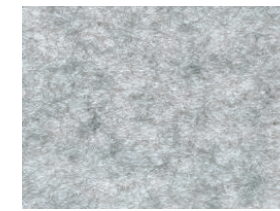

GREYSTONE



MIST



CRYSTAL

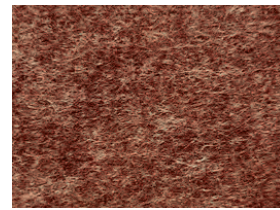

ESPRESSO

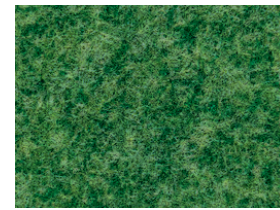

MOSS



SPRING

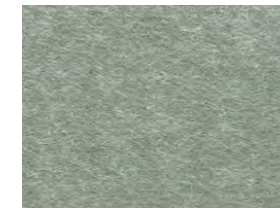

SAGE



CASTLEWALL

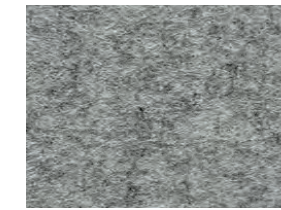

GRAPHITE

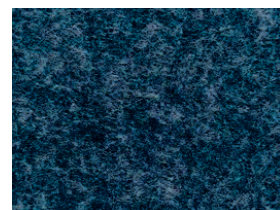

VINTAGE INDIGO

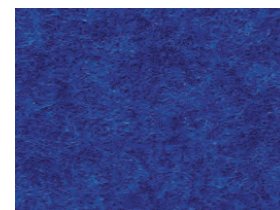

INDIGO

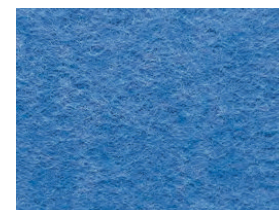

GLACIER

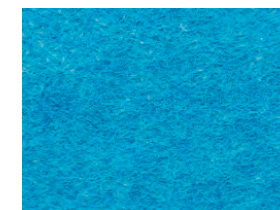

LAGOON

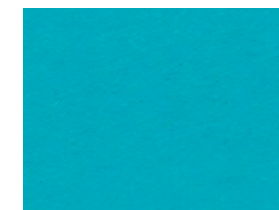

TROPICAL

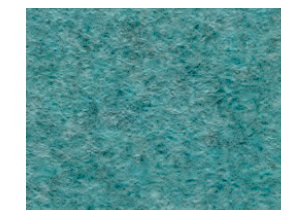

MYSTIC

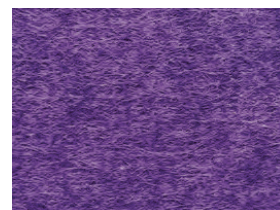

GRAPE



SEASHELL



MOCHA

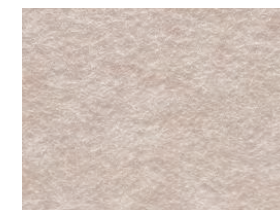

SANDSTONE

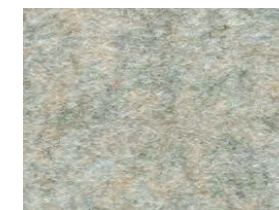

STONE

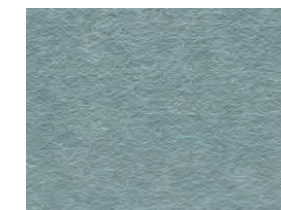

GALVANIZED



CARDINAL



CITRUS



TANGERINE



SOLAR



LEMON

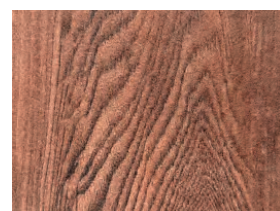

WALNUT

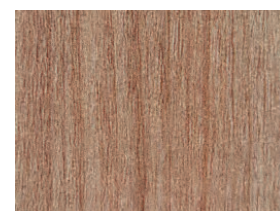

CEDAR

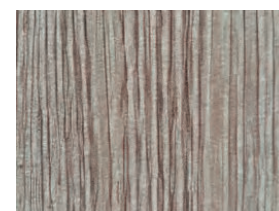

MAPLE

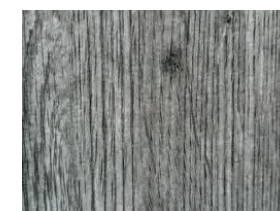

DRIFTWOOD

# HOW TO SPECIFY

Whether you have a specific product in mind or desire to craft a fully customized soundscape, our team is ready to bring your vision to life!

1

## CHOOSE YOUR SOUND SOLUTION

Looking to elevate how you address sound mitigation in your space? Explore our range of wall, ceiling, and screen solutions to begin shaping your ideal soundscape.

2

## REFINE THE DESIGN

Once you've selected your application and product, it's time to refine the design. Dive into our array of silhouettes, textures, patterns, and colors to customize your creation.

3

## SHARE YOUR VISION

Whether you already have a product and design in mind or require a fully custom solution, reach out to an ARTIZIN specialist or fill out the quote form on our website. A team member will walk you through each step of the process.

4

## GIVE US THE LOWDOWN

It's beneficial if you can provide our team with architectural drawings, field measurements, design inspiration, or design intent.



# INSTALLATION

Stick to our straight forward installation guidance then kick back and revel in the acoustic paradise you've crafted.

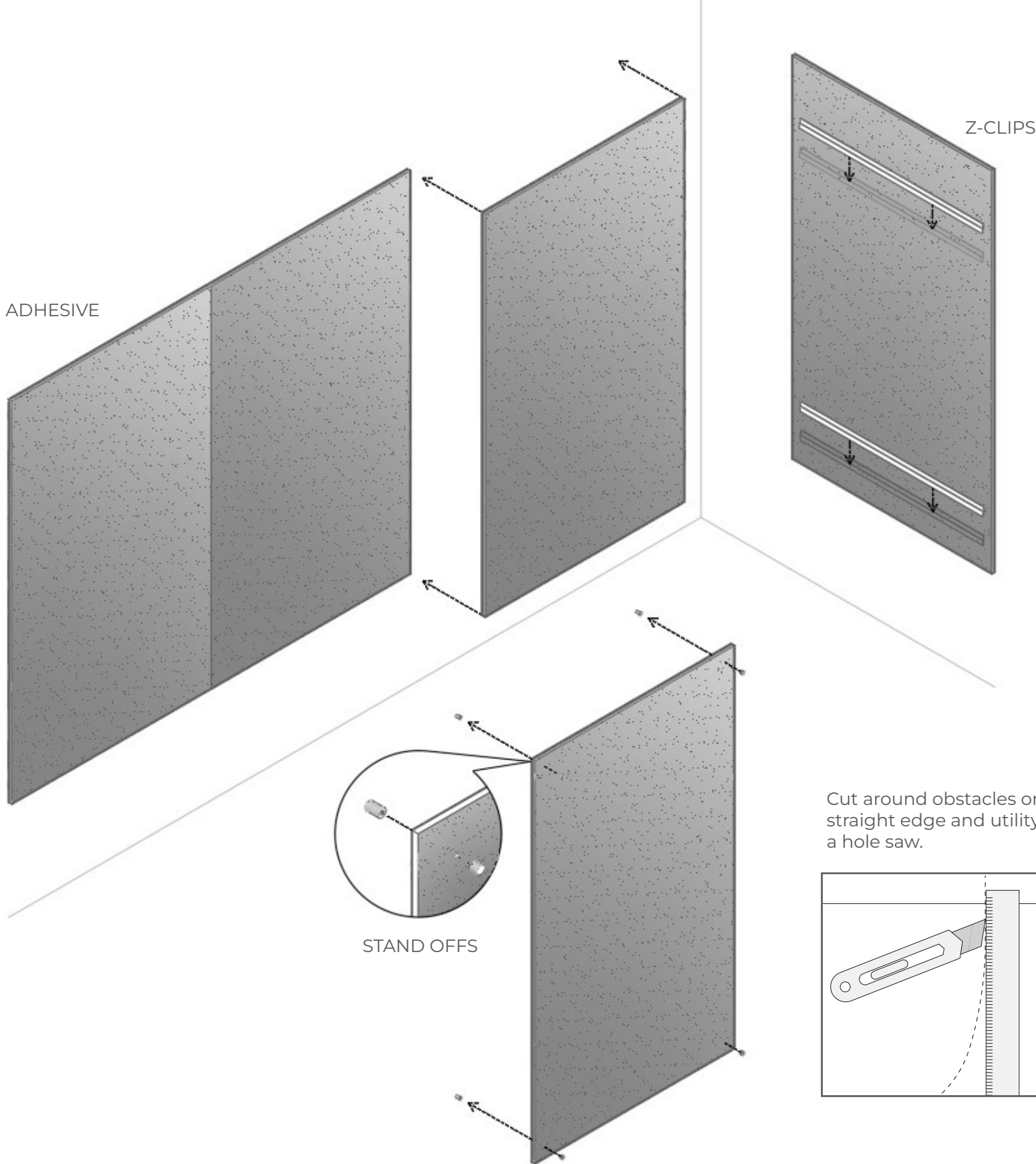

Cut around obstacles or trim panels to size using a straight edge and utility knife. For circular holes, use a hole saw.

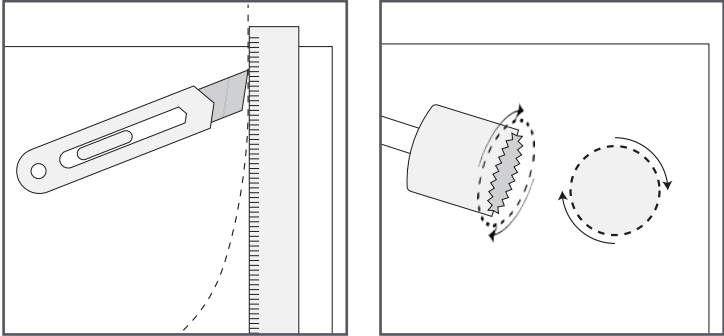

## PRODUCT SPECIFICATIONS

The details make all the difference. Dive into The specifics that contribute to the overall quality and functionality of our products.

<b>APPLICATION</b>	Wall
<b>MATERIAL</b>	9mm ArtFelt
<b>COMPOSITION</b>	60% Recycled Polyester Fiber, 40% Virgin Fiber
<b>DENSITY</b>	2000g/m2
<b>FORMALDEHYDE EMISSION</b>	0.00ug/g
<b>NRC RATING</b>	0.30-0.60
<b>FIRE TEST ASTM E 84-ISAN</b>	Class A
<b>SUSTAINABILITY</b>	Recyclable, Certified Clean Air Gold by Intertek Sustainability
<b>WARRANTY</b>	5 Year Limited Warranty
<b>SAFETY</b>	DECLARE, Red List Free
<b>LEAD TIME</b>	3-5 weeks for Standard, Request Lead Time for Custom

### GENERAL CARE

Vacuum as needed to remove dirt and dust. Use an air compressor for hard to reach areas.

### STAIN REMOVAL

Blot spills and spots immediately with a clean, soft white dry cloth (do not use paper products). Avoid using solvents or concentrated abrasives to clean ArtFelt. Always test in an inconspicuous area first.

### MILD STAIN REMOVAL

Blot ArtFelt with a clean, soft white cloth dampened with a mild solution of soap and warm water. Repeat using only clean water (no soap) to remove soap concentrate. Pat dry with a lint free cloth.

### CHALLENGING STAIN REMOVAL

Blot ArtFelt with a clean, soft white cloth dampened with a mixed solution of household bleach and water (70% bleach | 90% water). Repeat using only clean water (no bleach) to remove bleach concentration. Pat dry with a lint free cloth.



### CUSTOM

Connect with our team to design a fully custom solution. Through meticulous prototyping and the expertise of our skilled designers, we'll transform your vision into a tangible, personalized creation. Whether you're seeking intricate patterns, unique textures, or custom colors, we're here to translate ideas into inspired designs.