

WALL

DUO-PANELS

Double the visual and auditory impact with our Duo-Panels, featuring two ArtFelt™ panels seamlessly bonded into one cohesive piece. The dual-panel design not only enhances the ability to customize colors but also adds depth to your space, creating a striking visual dimension. Beyond aesthetics, Duo-Panels amplify noise reduction, making them the perfect solution for spaces that demand both style and acoustical performance.

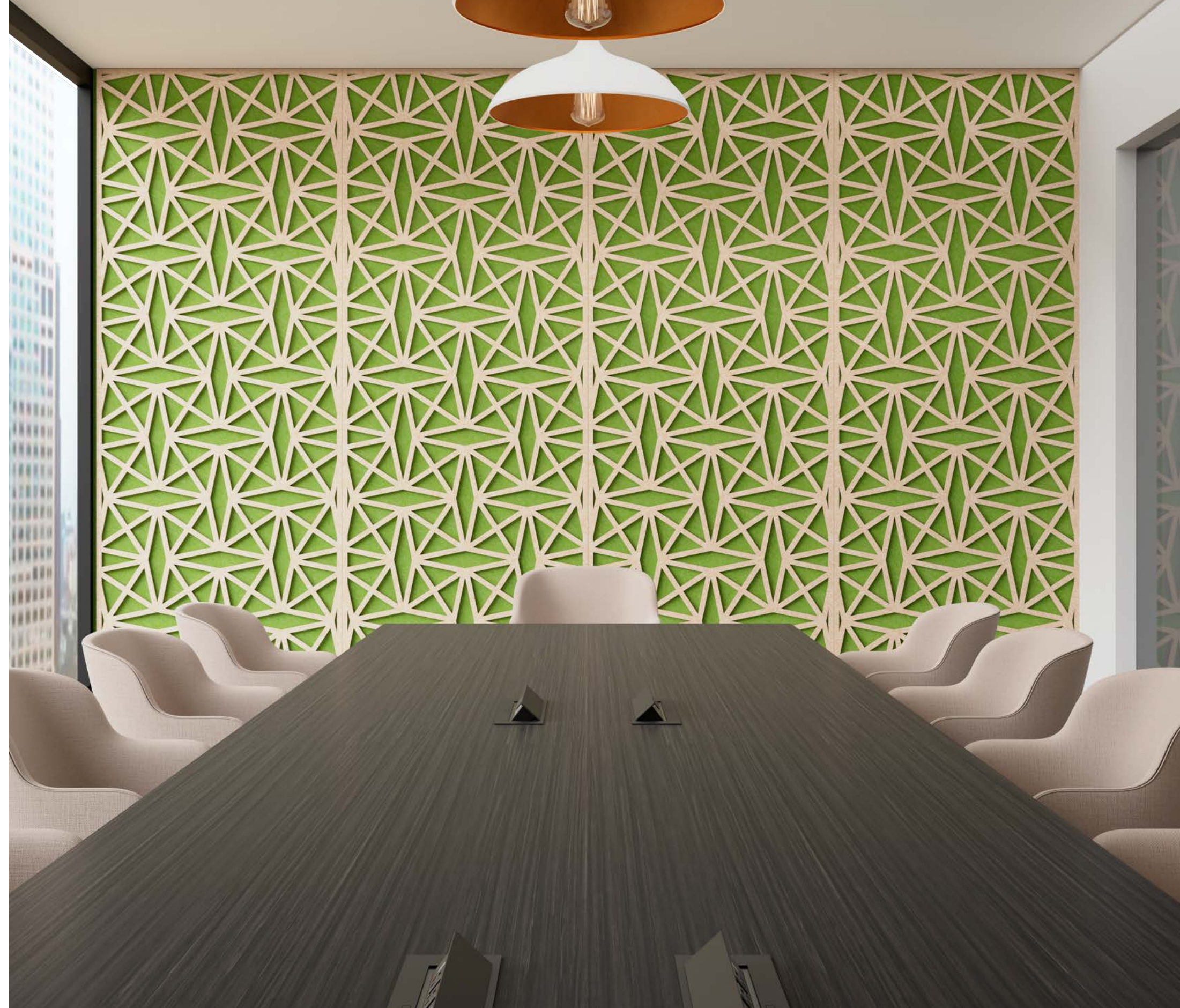

PATTERNS

Duo-Panels are 18mm thick and available in sizes of 47.5" x 95" or 47.5" x 118.75". With options like Duo-Cut Panels and Duo-Engraved Panels, you can explore techniques and various patterns. The unique ability to customize both the front and backer panels ensures your Duo product perfectly aligns with your aesthetic vision.

48" x 120" panels available in select colors.

DUO-CUT PATTERNS



ARROW 01



ARROW 02



CARTOON



DOT & DASH

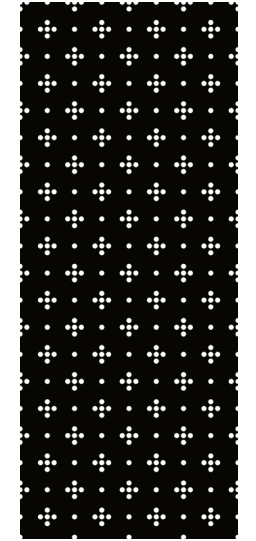

DOT FLOWER



FUNFETTI

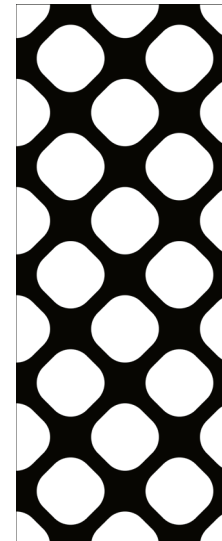

GRATE

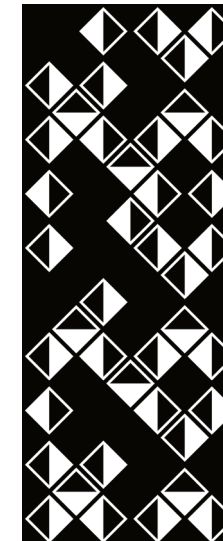

KITE



MATIRX

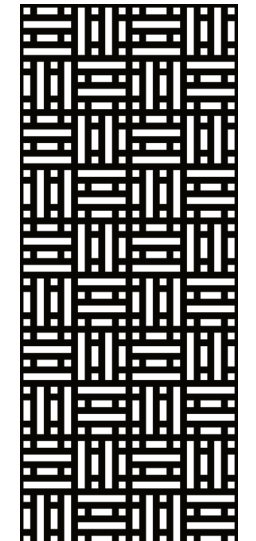

MOSAIC 02

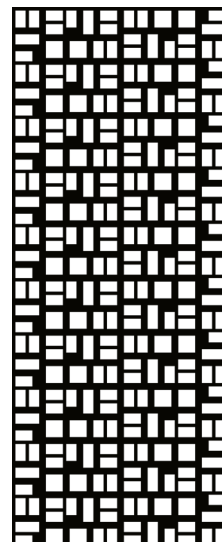

MOSAIC 03

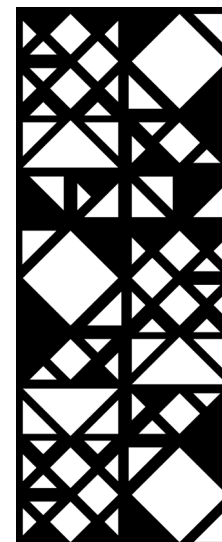

MOSAIC 04

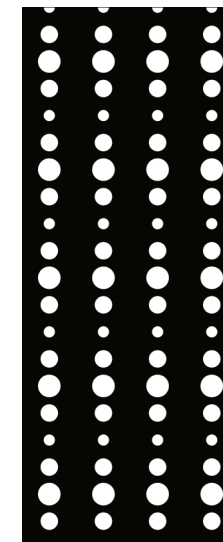

RAIN DOTS



RIPPLE

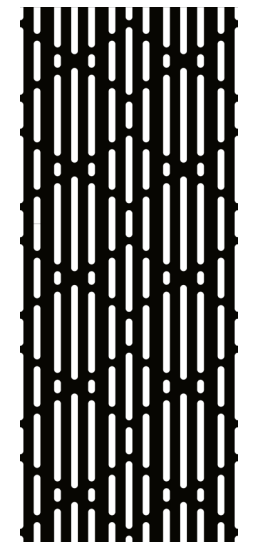

RUNWAY

PATTERNS

Duo-Panels are 18mm thick and available in sizes of 47.5" x 95" or 47.5" x 118.75". With options like Duo-Cut Panels and Duo-Engraved Panels, you can explore techniques and various patterns. The unique ability to customize both the front and backer panels ensures your Duo product perfectly aligns with your aesthetic vision.

48" x 120" panels available in select colors.

DUO-CUT PATTERNS

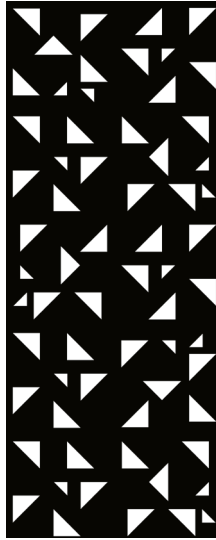

SHATTERED 01

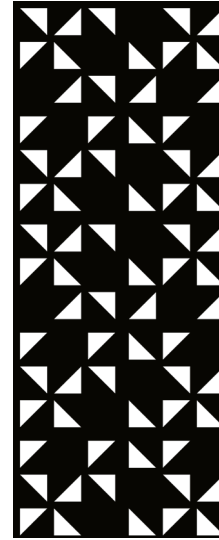

SHATTERED 02

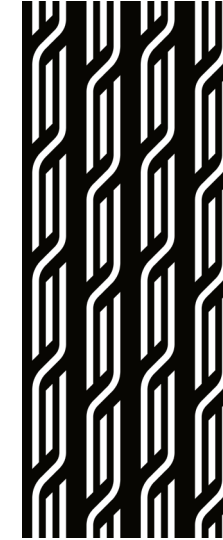

TREAD

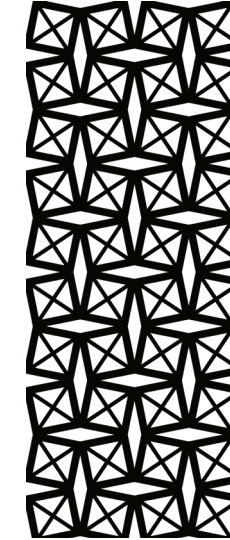

X-FACTOR

DUO-ENGRAVED PATTERNS

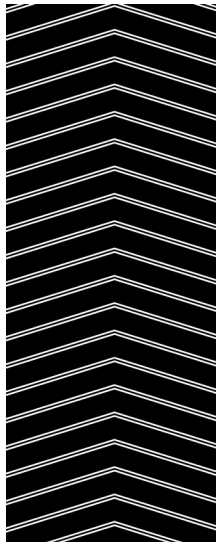

CHEVRON

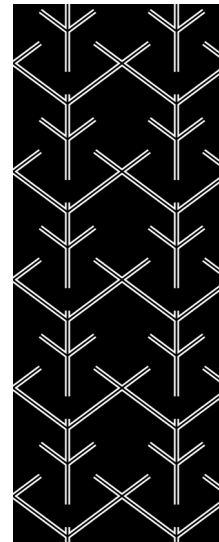

VERTEX

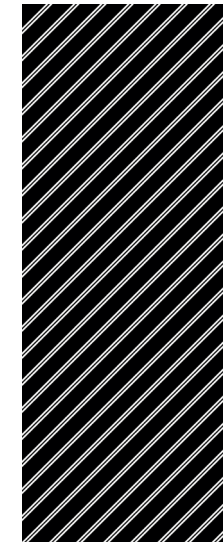

DIAGONAL

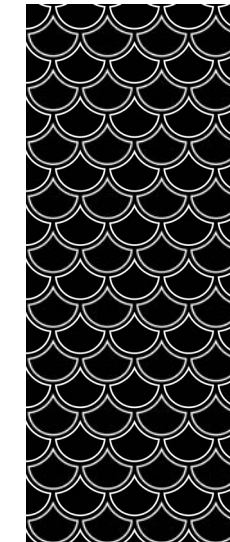

KOI

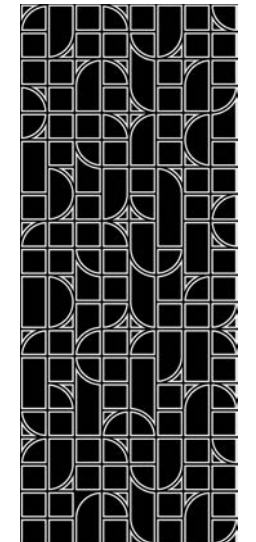

LUNAR

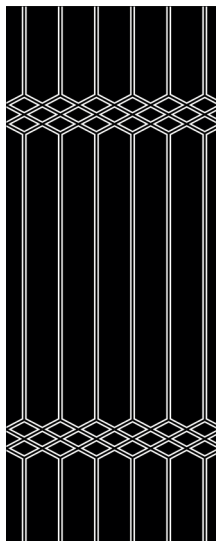

PRISM

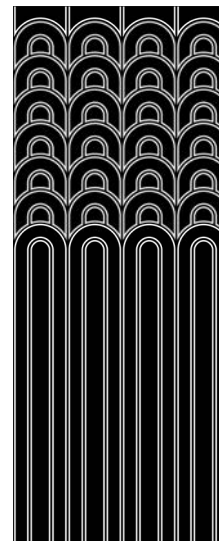

RAINBOW

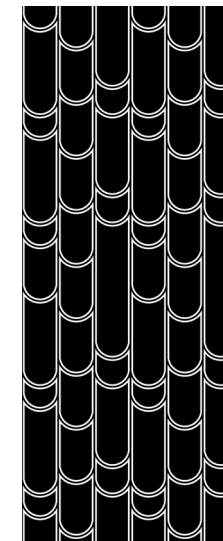

SCALLOP

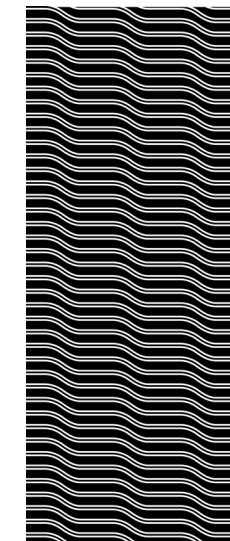

SLIDE

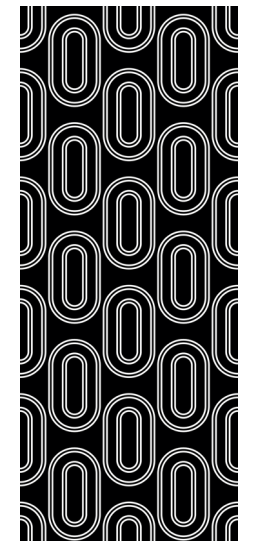

ZEN

COLOR GUIDE

9mm ArtFelt is the core material in our signature line of acoustic solutions. Duo products feature two of our 9mm ArtFelt panels bonded together. For a tone-on-tone look choose the same color for both panels. For more dimension, mix ArtFelt colors.

Request samples to verify color as printers and monitors vary.

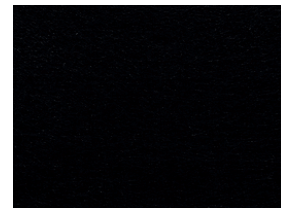

ECLIPSE

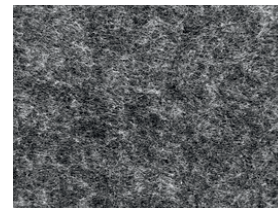

ASH

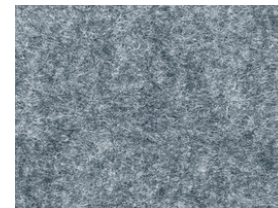

WEATHERED



GREYSTONE



MIST

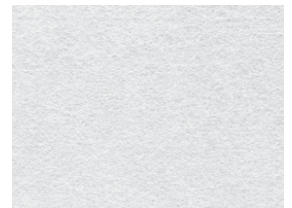

CRYSTAL

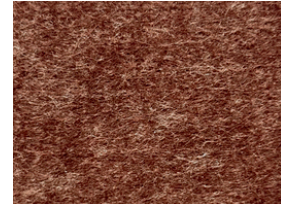

ESPRESSO



MOSS



SPRING

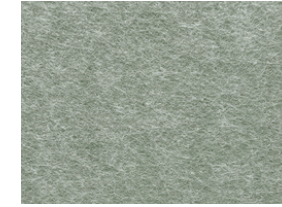

SAGE



CASTLEWALL

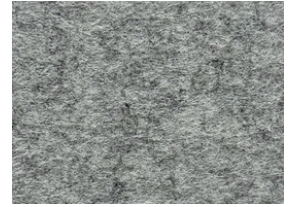

GRAPHITE



VINTAGE INDIGO

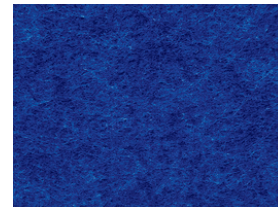

INDIGO



GLACIER



LAGOON



TROPICAL



MYSTIC

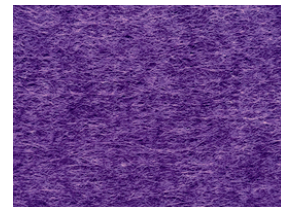

GRAPE



SEASHELL



MOCHA



SANDSTONE



STONE



GALVANIZED



CARDINAL



CITRUS



TANGERINE



SOLAR



LEMON



WALNUT

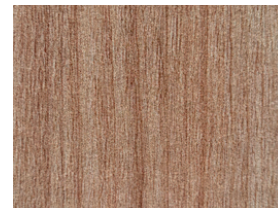

CEDAR

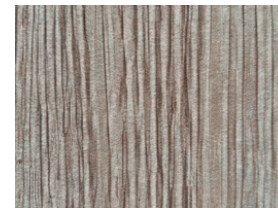

MAPLE

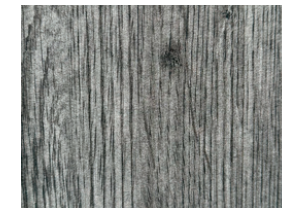

DRIFTWOOD

HOW TO SPECIFY

Whether you have a specific product in mind or desire to craft a fully customized soundscape, our team is ready to bring your vision to life!

1

CHOOSE YOUR SOUND SOLUTION

Looking to elevate how you address sound mitigation in your space? Explore our range of wall, ceiling, and screen solutions to begin shaping your ideal soundscape.

2

REFINE THE DESIGN

Once you've selected your application and product, it's time to refine the design. Dive into our array of silhouettes, textures, patterns, and colors to customize your creation.

3

SHARE YOUR VISION

Whether you already have a product and design in mind or require a fully custom solution, reach out to an ARTIZIN specialist or fill out the quote form on our website. A team member will walk you through each step of the process.

4

GIVE US THE LOWDOWN

It's beneficial if you can provide our team with architectural drawings, field measurements, design inspiration, or design intent.

INSTALLATION

Stick to our straight forward installation guidance then kick back and revel in the acoustic paradise you've crafted.

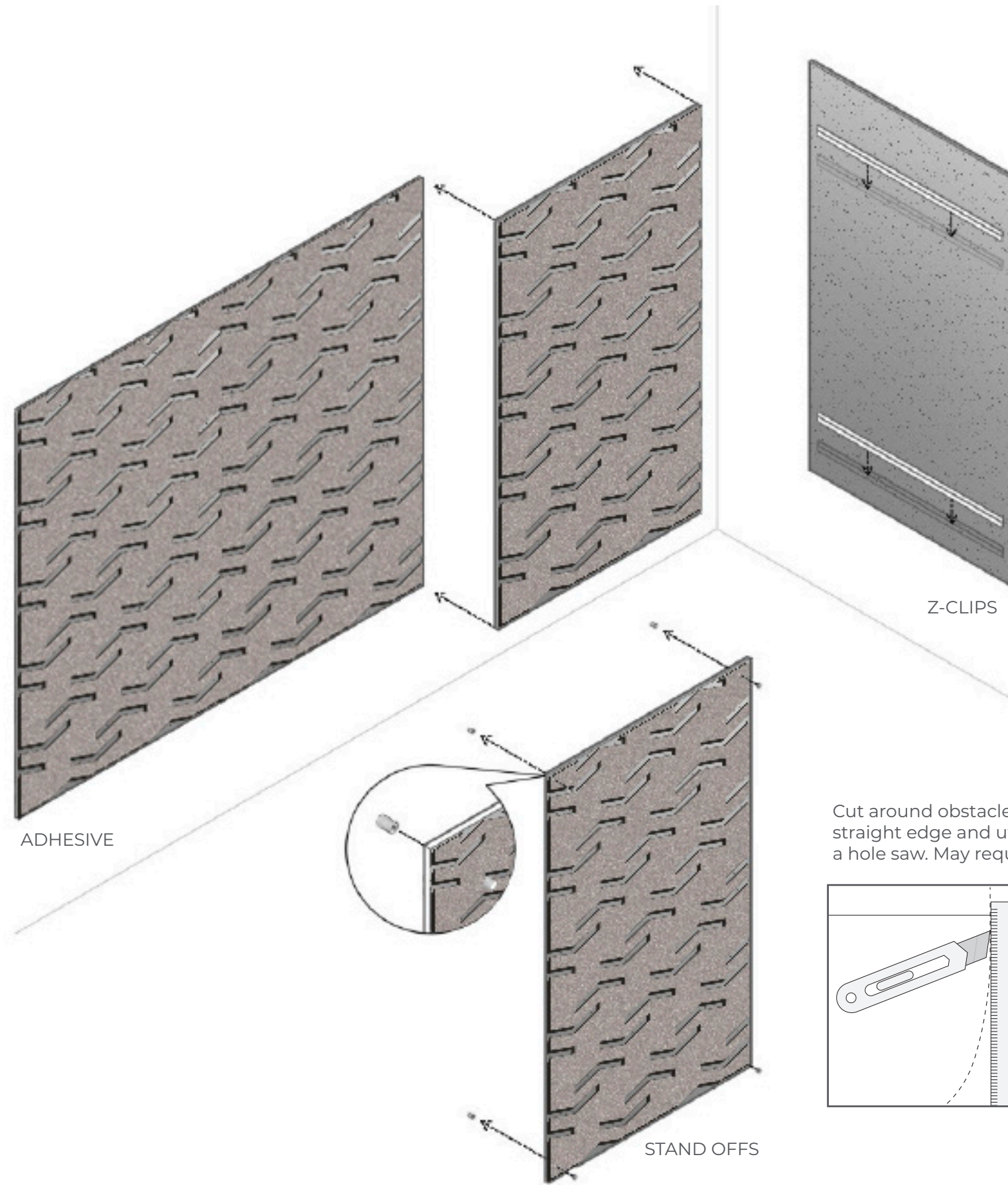

Cut around obstacles or trim panels to size using a straight edge and utility knife. For circular holes, use a hole saw. May require multiple passes

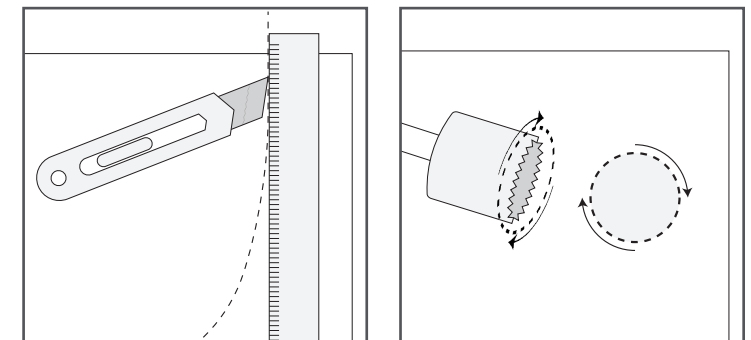

PRODUCT SPECIFICATIONS

The details make all the difference. Dive into the specifics that contribute to the overall quality and functionality of our products.

APPLICATION	Wall
MATERIAL	18mm ArtFelt
COMPOSITION	60% Recycled Polyester Fiber, 40% Virgin Fiber
DENSITY	3740g/m2
FORMALDEHYDE EMISSION	0.00ug/g
NRC RATING	0.60
FIRE TEST ASTM E 84-ISAN	Class A
SUSTAINABILITY	Recyclable, Certified Clean Air Gold by Intertek Sustainability
WARRANTY	5 Year Limited Warranty
SAFETY	DECLARE, Red List Free
LEAD TIME	3-5 weeks for Standard, Request Lead Time for Custom

GENERAL CARE

Vacuum as needed to remove dirt and dust. Use an air compressor for hard to reach areas.

STAIN REMOVAL

Blot spills and spots immediately with a clean, soft white dry cloth (do not use paper products). Avoid using solvents or concentrated abrasives to clean ArtFelt. Always test in an inconspicuous area first.

MILD STAIN REMOVAL

Blot ArtFelt with a clean, soft white cloth dampened with a mild solution of soap and warm water. Repeat using only clean water (no soap) to remove soap concentrate. Pat dry with a lint free cloth.

CHALLENGING STAIN REMOVAL

Blot ArtFelt with a clean, soft white cloth dampened with a mixed solution of household bleach and water (10% bleach | 90% water). Repeat using only clean water (no bleach) to remove bleach concentration. Pat dry with a lint free cloth.



CERTIFIED
CLEAN AIR GOLD



IIDA
INDUSTRY
MEMBER

CUSTOM

Connect with our team to design a fully custom solution. Through meticulous prototyping and the expertise of our skilled designers, we'll transform your vision into a tangible, personalized creation. Whether you're seeking intricate patterns, unique textures, or custom colors, we're here to translate ideas into inspired designs.